



3³/₄ x 6³/₄''' ETA 280.002

CT 280002 FDE 291934 05 18.01.2010

3³/₄ x 6³/₄''' Ø 9,00 x 15,15 mm

Hauteur sur mouvement	Höhe auf Werk	Movement height	1,80 mm
Hauteur sur pile	Höhe auf Batterie	Height on battery	2,05 mm
Nombre de rubis	Anzahl Rubine	Number of jewels	5
Fréquence	Frequenz	Frequency	32'768 Hz

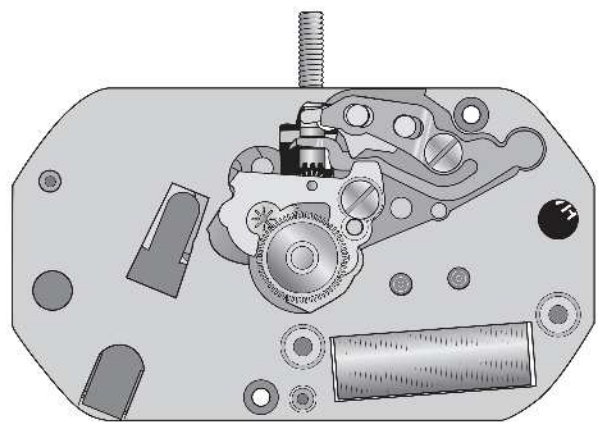
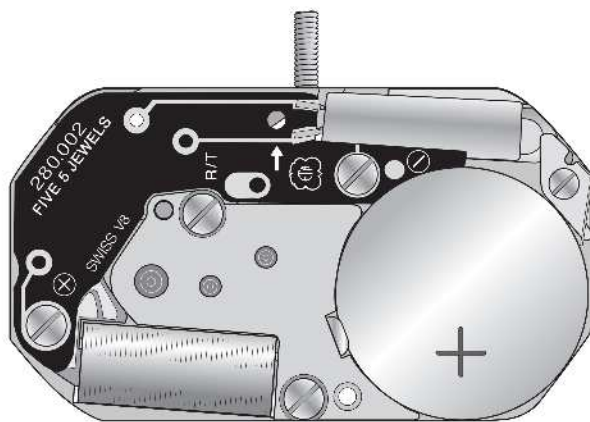
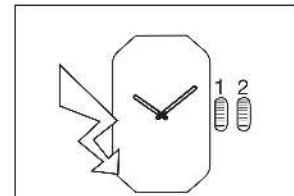

Les travaux de réparation et de révision ne doivent être effectués que par du personnel dûment formé.
Reparatur- und Revisionsarbeiten dürfen nur von ausgebildetem Fachpersonal ausgeführt werden.
The repair and reconditioning work must only be performed by properly trained personnel.



Liste des fournitures - Bestandteilliste - List of components

Pos	No Nr No	No Nr CS No	Numéro d'article Artikelnummer Article number		Liste des fournitures	Bestandteilliste	List of components
-	100	10.020.07	-		Platine garnie	Ausgerüstete Werkplatte	Main plate, mounted
-	110	10.048.07	-		Pont de rouage, empierré	Räderwerkbrücke, mit Steinen	Train wheel bridge, jewelled
-	163	81.337.00	-		Tenon de chaussée	Lagerstift für Minutenrohr	Cannon pinion stud
-	203	30.012.00	-		Roue intermédiaire	Zwischenrad	Intermediate wheel
-	210	30.025.00	-		Roue moyenne	Kleinbodenrad	Third wheel
-	242/1	31.083.18	-		Chaussée avec entraîneur	Minutenrohr mit Mitnehmer	Cannon pinion with driver
-	250/1	31.046.06	-		Roue des heures, montée	Stundenrad, montiert	Hour wheel, assembled
-	260	31.041.00	-		Roue de minuterie	Wechselrad	Minute wheel
-	405	51.020.20	-		Tige de mise à l'heure, diamètre de filetage 0,90 mm	Stellwelle, Gewindedurchmesser 0,90 mm	Handsetting stem, thread diameter 0,90 mm
-	407	31.121.00	-		Pignon coulant	Kupplungstrieb	Sliding pinion
-	435	51.050.00	-		Bascule-ressort	Kupplungstriebhebel	Yoke
-	443	51.080.00	-		Tirette	Winkelhebel	Setting lever
-	450	31.100.00	-		Renvoi	Zeigerstellrad	Setting wheel
-	462	10.062.00	-		Pont de rouage de minuterie	Wechselradbrücke	Minute train bridge
-	4000	10.513.00	-		Module électronique	Elektronik-Baugruppe	Electronic module
-	4021	20.582.00	-		Stator	Stator	Stator
-	4046	20.651.00	-		Isolateur de pile	Isolation für Batterie	Battery insulator
-	4060	20.590.00	-		Bobine	Spule	Coil
-	4211	20.580.00	-		Rotor	Rotor	Rotor
-	4400	51.600.00	-		Bride de fixation de pile	Batteriehaltebügel	Battery clamp
-	4401	20.761.00	-		Bride +	Bügel +	Bridle +
-	4929	20.570.01	-		Pile Ø 6,80 mm, H. 1,65 mm	Batterie Ø 6,80 mm, H. 1,65 mm	Battery Ø 6.80 mm, H. 1.65 mm
1)	5110	10.048.01	-	2x	Vis de pont de rouage	Schraube für Räderwerkbrücke	Screw for train wheel bridge
2)	5435	51.050.01	-	1x	Vis de bascule-ressort	Schraube für Federwippe	Screw for spring-yoke
2)	5462	10.062.01	-	1x	Vis de pont de rouage de minuterie	Schraube für Wechselradbrücke	Screw for minute train bridge
-	54000	10.513.01	-	2x	Vis de module électronique	Schraube für Elektronik-Baugruppe	Screw for electronic module
1)	54062	20.590.01	-	1x	Vis de bobine	Schraube für Spule	Screw for coil
2)	54401	20.761.01	-	1x	Vis de bride +	Schraube für Bügel +	Screw for bridle +
					Vis identiques Identische Schrauben Identical screws	1) 5110 54060	2) 5435 5462 54401
			Var		Variante	Variante	Variant

**L'interchangeabilité et les variantes se trouvent sur
ETA ONLINE SHOP (EOS) :**

www.eta.ch
→ Customer Service
→ Customer Service Portal











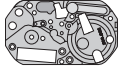













**Die Austauschbarkeit und Varianten finden Sie im
ETA ONLINE SHOP (EOS):**

www.eta.ch
→ Customer Service
→ Customer Service Portal

**Interchangeability and variants
can be found on the
ETA ONLINE SHOP (EOS):**

www.eta.ch
→ Customer Service
→ Customer Service Portal

Fournitures - Bestandteile - Materials

								
100	110	163	203	210	242/1	250/1	260	5110 54060
								
405	407	435	443	450	462	4000	5435 5462 54401	
								
4021	4046	4060	4211	4400	4401	4929	54000	